

Product Summary

$V_{(BR)DSS}$	$R_{DS(on)TYP}$	I_D
20V	47mΩ@4.5V	2A
	64mΩ@2.5V	

Feature

- Trench Technology Power MOSFET
- Low $R_{DS(ON)}$
- Low Gate Charge

Application

- Power Switching Application
- PWM applications
- Power management

MARKING:

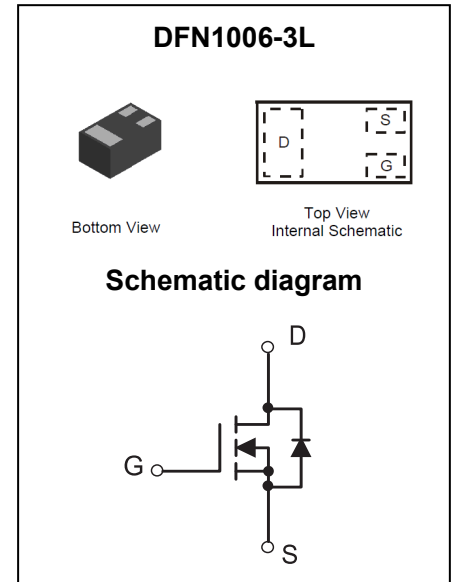
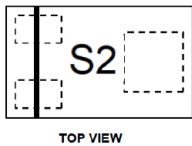

ABSOLUTE MAXIMUM RATINGS ($T_A = 25^\circ\text{C}$ unless otherwise noted)

Parameter	Symbol	Value	Unit
Drain - Source Voltage	V_{DS}	20	V
Gate - Source Voltage	V_{GS}	±12	V
Continuous Drain Current ^{1,5}	I_D	2	A
Pulsed Drain Current ²	I_{DM}	6	A
Power Dissipation ^{4,5}	P_D	0.3	mW
Thermal Resistance from Junction to Ambient ⁵	$R_{\theta JA}$	420	$^\circ\text{C}/\text{W}$
Junction Temperature	T_J	150	$^\circ\text{C}$
Storage Temperature	T_{STG}	-55~ +150	$^\circ\text{C}$

MOSFET ELECTRICAL CHARACTERISTICS ($T_A = 25^\circ\text{C}$ unless otherwise noted)

Parameter	Symbol	Test Condition	Min	Type	Max	Unit
Off Characteristics						
Drain - Source Breakdown Voltage	$V_{(BR)DSS}$	$V_{GS} = 0V, I_D = 250\mu A$	20			V
Zero Gate Voltage Drain Current	I_{DSS}	$V_{DS} = 20V, V_{GS} = 0V$			1	μA
Gate - Body Leakage Current	I_{GSS}	$V_{GS} = \pm 12V, V_{DS} = 0V$			± 100	nA
On Characteristics³						
Gate Threshold Voltage	$V_{GS(th)}$	$V_{DS} = V_{GS}, I_D = 250\mu A$	0.4	0.7	1	V
Drain-source On-resistance	$R_{DS(on)}$	$V_{GS} = 4.5V, I_D = 1A$		47	65	m Ω
		$V_{GS} = 2.5V, I_D = 1A$		64	85	
Dynamic Characteristics⁴						
Input Capacitance	C_{iss}	$V_{DS} = 10V, V_{GS} = 0V, f = 1MHz$		135		pF
Output Capacitance	C_{oss}			27		
Reverse Transfer Capacitance	C_{rss}			25		
Gate Resistance	R_g	$V_{DS} = 0V, V_{GS} = 0V, f = 1MHz$		7.7		Ω
Switching Characteristics⁴						
Total Gate Charge	Q_g	$V_{DS} = 10V, V_{GS} = 4.5V, I_D = 2A$		2.5		nC
Gate-source Charge	Q_{gs}			0.5		
Gate-drain Charge	Q_{gd}			0.6		
Turn-on Delay Time	$t_{d(on)}$	$V_{DD} = 6V, V_{GS} = 4.5V, I_D = 0.5A,$ $R_G = 50\Omega, R_L = 12\Omega$		4		ns
Turn-on Rise Time	t_r			29		
Turn-off Delay Time	$t_{d(off)}$			7		
Turn-off Fall Time	t_f			22		
Source - Drain Diode Characteristics						
Diode Forward Voltage ³	V_{SD}	$V_{GS} = 0V, I_S = 0.1A$			1.2	V

Notes :

- 1.The maximum current rating is limited by package.
- 2.Pulse Test : Pulse Width $\leq 10\mu s$, duty cycle $\leq 1\%$.
- 3.Pulse Test : Pulse Width $\leq 300\mu s$, duty cycle $\leq 2\%$.
- 4.The power dissipation P_D is limited by $T_{J(MAX)} = 150^\circ\text{C}$.
- 5.Device mounted on 1in² FR-4 board with 2oz. Copper, in a still air environment with $T_A = 25^\circ\text{C}$.

Typical Characteristics

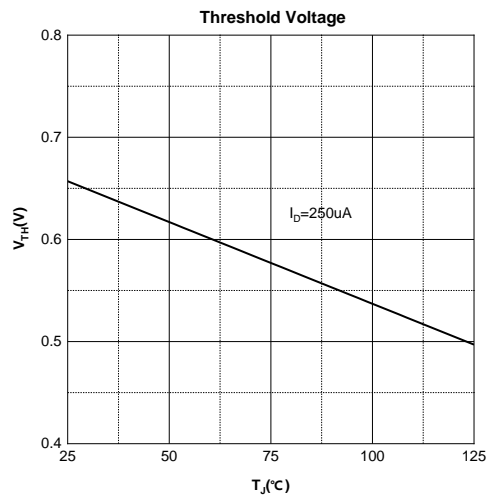
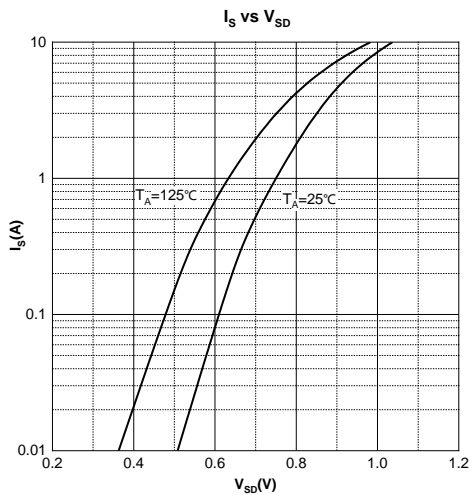
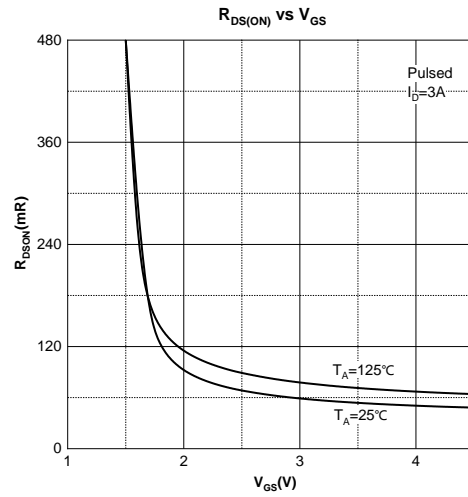
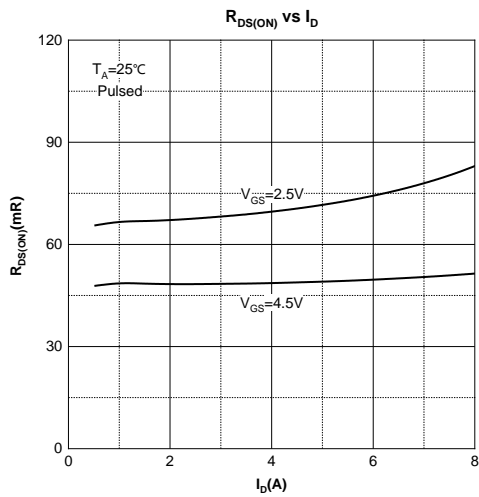
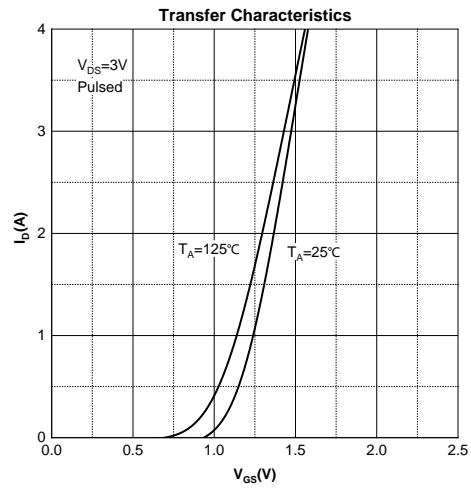
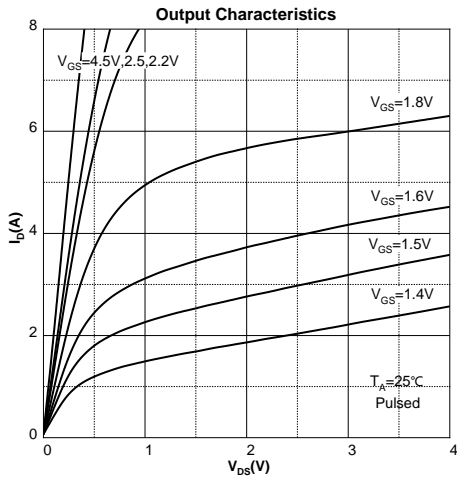

DFN1006-3L Package Information

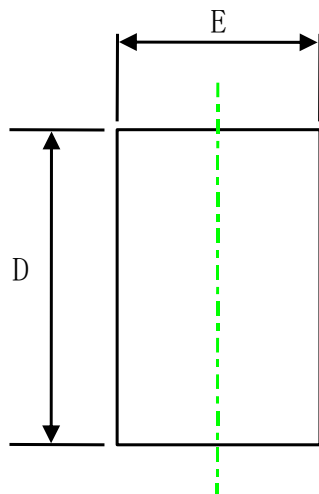

TOP VIEW
[顶视图]

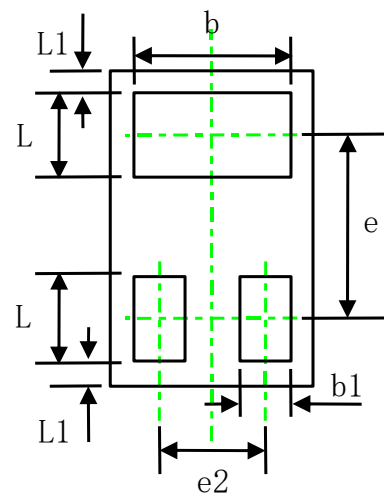

BOTTOM VIEW
[底视图]

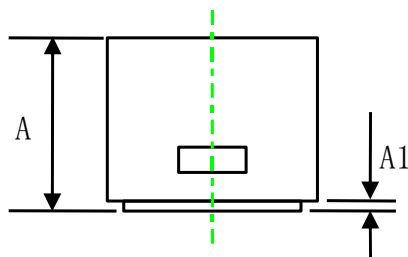

SIDE VIEW
[侧视图]

Symbol	Dimensions In Millimeters		Dimensions In Inches	
	Min.	Max.	Min.	Max.
A	0.400	0.550	0.016	0.022
A1	0.000	0.050	0.000	0.002
D	0.950	1.050	0.037	0.041
E	0.550	0.650	0.022	0.026
b	0.400	0.600	0.016	0.024
e	0.65 TYP		0.026 TYP	
e2	0.35 TYP		0.014 TYP	
L1	0.05 REF		0.002 REF	
L	0.200	0.300	0.008	0.012
b1	0.100	0.200	0.004	0.008

Attention:

- GreenPower Electronics reserves the right to improve product design function and reliability without notice.
- Any and all semiconductor products have certain probability to fail or malfunction, which may result in personal injury, death or property damage. Customer are solely responsible for providing adequate safe measures when design their systems.
- GreenPower Electronics products belong to consumer electronics or other civilian electronic products.